

Coupling of a 2.5 kW steam reformer with a 1 kW_{el} PEM fuel cell

J. Mathiak¹, A.Heinzel^{1,2}, J. Roes^{1,2*}, Th. Kalk¹, H. Kraus¹, H. Brandt²

¹ Zentrum für BrennstoffzellenTechnik GmbH (ZBT GmbH), Carl-Benz-Strasse 201, 47058 Duisburg, Germany

² Universität Duisburg-Essen, Institut für Energie- und Umweltverfahrenstechnik, Lotharstrasse 1, 47057 Duisburg, Germany

* corresponding author:

Tel. 0049 (0) 203 / 379 3010

Fax 0049 (0) 203 / 379 2720

Email J.Roes@uni-duisburg.de

Abstract

The University of Duisburg-Essen has developed a compact multi-fuel steam reformer suitable for natural gas, propane and butane. This steam reformer was combined with a PEM fuel cell and a system test of the process chain was performed. The fuel processor comprises a prereformer step, a primary reformer, water gas shift reactors, a steam generator, internal heat exchangers in order to achieve an optimised heat integration and an external burner for heat supply as well as a preferential oxidation step (PrOx) as CO purification. The fuel processor is designed to deliver a thermal hydrogen power output from 500 W to 2,5 kW. The PEM fuel cell stack provides about 1 kW electrical power. In the following paper experimental results of measurements of the single components PEM fuel cell and fuel processor as well as results of the coupling of both to form a process chain are presented.

Keywords: PEM fuel cell, steam reformer, selective oxidation, residential power supply

Introduction

While establishing polymer electrolyte membrane fuel cells (PEM FC) for residential power supply it is currently being noticed that the development of a total system involves considerable technical problems. The main issues for the developers are the complexity of the total system, efficiency, reliability, durability, size and volume and last but not least the necessary invest cost at the time being. The problems are located in the optimisation of the components like gas treatment, reformer, heat exchangers, blowers, valves and controls with respect to the special requirements of the fuel cells and in the interaction when the components are integrated in an overall system. It is well known, that one of the weak technological points is the hydrogen generation and the hydrogen treatment in a reformer system.

The University of Duisburg-Essen in cooperation with the partners AGEF e.V., rhenag, ruhrgas AG and ZBT GmbH is currently developing a fully-integrated, compact residential power supply system. It will consist of a natural gas fuel processor based on steam reforming, a PEM fuel cell, peripheral components (pumps, blowers and valves) and controls. The target output of the fuel cell is about 1 kW_{el} to be suitable for applications in single-family houses. The current focus of the project is set on the characterisation of the main components steam reformer including a preferential oxidation step as CO purification (PrOx) and fuel cell stack as well as the combining of these components to a process chain. Laboratory testing has been performed in order to investigate the steady state behaviour at rated power and at different part load operating points as well as the dynamic load change behaviour of the complete process chain. The fuel processor performance like gas composition and efficiency will be presented. The fuel cell stack behaviour like electrical power output and fuel utilisation as well as the total system behaviour in terms of efficiency and dynamic will also be introduced.

Experimental investigation of the fuel cell stack

PEM fuel cells are well qualified for household applications because of the high power density and the operating temperature level of about 60 to 80 °C to supply heat for hot water for domestic use or to support the room heating system of the building. A prototype fuel cell stack from Proton Motor, Starnberg, Germany, built 2001, suitable for reformat gas and operating at nearly ambient pressure was selected. The chosen fuel cell meets a lot of typical requirements with respect to residential power supply applications. Particularly a low pressure drop at anode and cathode side, a low air to fuel ratio and the feature of internal humidification of the cathode air are remarkable stack issues in order to achieve an efficient and less complex total system. The following table 1 represents the most important design specifications of the fuel cell stack.

Table 1: Specifications and features of the 1 kW PEM fuel cell stack

Technical Data / Feature	Figure / Description	Remark
Electrical power output	1.2 kW	With pure hydrogen
Number of cells	20	
Operating voltage	11 – 18 V	
Gas quality	Reformat gas	
Tolerable CO content	50 ppm	Airbleed necessary
Operating temperature	50 – 75 °C	
Operating pressure	Ca. ambient pressure	
Cooling	Water cooled	Tolerable temperature $\Delta T = 20$ °C
Pressure drop anode side	About 100 mbar	@ rated power
Pressure drop cathode side	About 100 mbar	@ rated power
Humidification anode side	None	Humid reformat gas used
Humidification cathode side	Internal	
Air ratio	$\lambda = 2$	Referred to converted H ₂

The PEM stack was tested with different fuel gases. First pure hydrogen was employed in order to get a benchmark to evaluate the stack behaviour with synthetic reformat gas with and without traces of carbon monoxide. The fuel cell stack was characterised and evaluated on a special designed test rig. Figure 1 shows a principal schematic of the test facility. The main components of the test rig are a gas supply based on mass flow controllers (MFC), which allows to provide various feed gas compositions in order to simulate typical steam reformat gas, a tempered humidifier to ensure a defined moistness of the fuel gas (for all introduced measurements the fuel gas was moistened to 100 % relative humidity), the fuel cell stack with voltage control of each single cell and electric load, an air supply for the cathode side and a tempered water cooling cycle to keep the stack temperature constant for defined experimental boundary conditions. The measuring data of the gauged pressures and temperatures, the electrical load and the single voltages of each cell were continuously logged during the tests.

Figure 2 presents a polarisation curve and the electrical power output of the fuel cell stack with pure hydrogen as a function of the current density. The feed gas temperature was kept constant at about 55 °C and was moistened to 100 % relative humidity. During the measurements a fuel utilisation f_u of 50 % at the anode side and an air ratio λ of 2 (corresponding to the converted hydrogen) were adjusted. The operating pressure of the stack is in the range of ambient pressure while relatively low pressure drops at anode and cathode side of about 100 mbar can be observed at full load. The diagram shows a maximum power density of 0.11 W/cm² resulting in an electrical output of 705 W at a very moderate current density of 0.17 A/cm² due to the limits of the used mass flow controllers. Hence, the hydrogen volume flow was restricted to 14 l_{s.t.p.}/min corresponding to 2.5 kW_{th} hydrogen power (based on the lower heating value of hydrogen of 10 800 kJ/m³). The voltage efficiency η_v , which may be defined as average cell voltage referred to the Free Enthalpie $\Delta G_0 = -237.3$ kJ/mol resulting in a reversible cell voltage of 1.23 V, is about

$$\eta = \frac{0.70 \text{ V}}{1.23 \text{ V}} = 0.569$$

or 56.9 % at 705 W power output. Nevertheless, the stack is able to provide a maximum electrical power output of about 1.2 kW with pure hydrogen as fuel gas. Each measuring point in the diagram represents the average of three single gaugings. The selected and investigated fuel cell stack is not optimised in order to achieve a high power density but, as already mentioned, with respect to appropriateness for residential power supply for low pressure operation and low pressure drops in order to reduce parasitic losses and the power demand for the peripheral components. Nevertheless, today stacks from PM can achieve higher current densities due to a significant progress of the stack development.

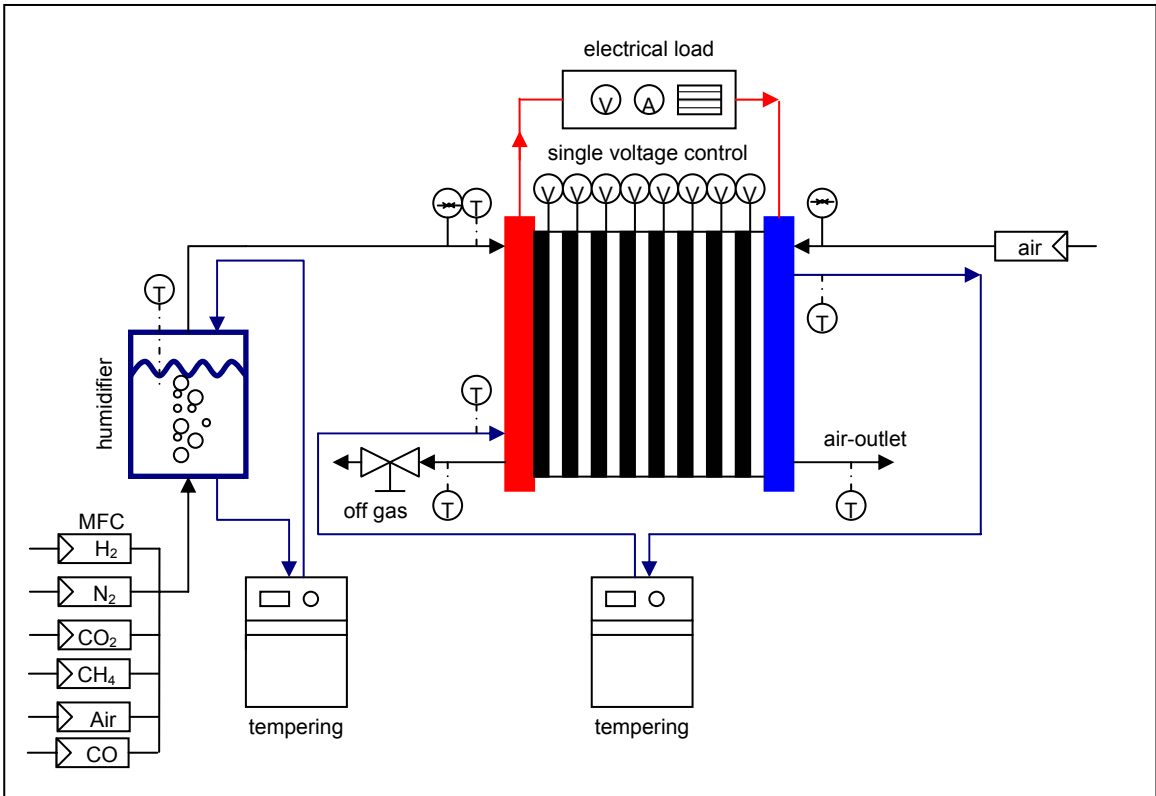

Figure 1: Fuel cell stack test rig with gas supply, electric load and water cooling cycle

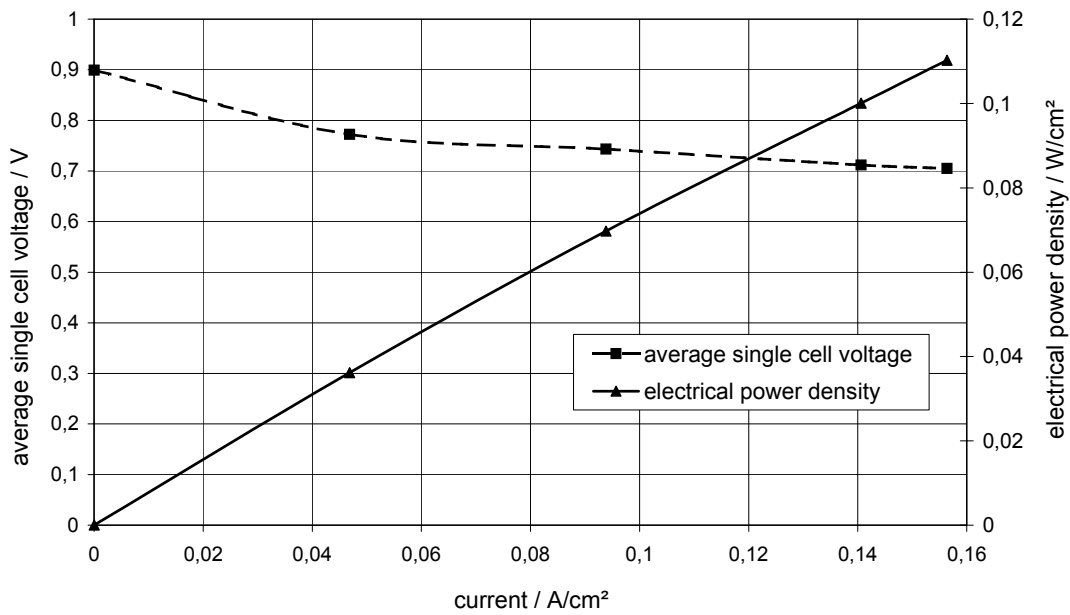

Figure 2: Polarisation curve and electrical power output as a function of current density at a fuel utilisation f_u of 0.5, air ratio λ of 2 and an average stack temperature of 58 °C

In order to characterize the fuel cell stack behaviour for reformat gas the method of characterization had to be changed. The range of composition of a typical reformat gas is already well known from comprehensive simulations [1] and extensive experimental investigations [2, 3]. Hence, for the described experimental investigations a gas composition of 76 % H₂, 19.2 % CO₂, 3.8 % N₂ and 1 % CH₄ on dry basis was used in order to simulate a natural gas reformat including PROX as CO purification step. Additionally traces of CO between 0 and 50 ppm were added to the fuel gas. Before entering the fuel cell stack the gas stream was moistened up to 100 % relative humidity. Figure 3 shows an important and remarkable result of the performed measurements. Firstly the graph measured with pure hydrogen sets the benchmark for performance evaluation. The stack achieves an electrical power output of 1.05 kW at a current density 0.265 A/cm² with pure hydrogen corresponding to a voltage efficiency $\eta_V = 0.5$ based on an average single cell voltage of 0.618 V.

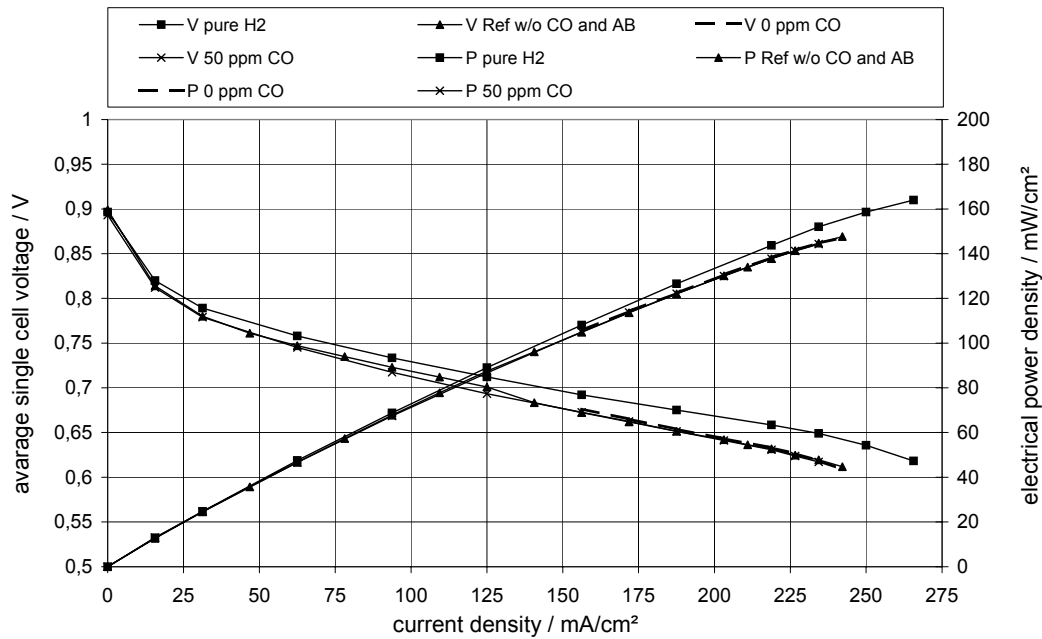

Figure 3: Polarisation curve and electrical power output with and without air bleed (AB) and carbon monoxide at an average stack temperature of 65 °C and variable fuel utilisation f_u

Then a test with reformat gas but without CO was performed in order to evaluate the influence of the air bleed on stack performance. The graphs in figure 3 show no significant deviation between the measurements without air bleed (V Ref w/o CO and AB, P Ref w/o CO and AB) and the measurements with an air bleed (V 0 ppm CO, P 0 ppm CO) of 10 vol.-% air added to the fuel gas stream. In both cases the polarisation curve and the graph of the electrical power output is slightly lower than the graph for pure hydrogen but no influence of the air bleed on the short term performance of the fuel cell can be observed. The stack achieves a maximum electric power output of 950 W under these conditions. Furthermore no significant influence of added carbon monoxide could be detected. The air bleed removes CO traces up to 50 ppm without a clear performance loss. The voltage efficiency η_V amounts to 0.49 and the fuel utilisation is about 78 %. The optimal air bleed ratio was found to be 4.5 vol.-% of the reformat gas.

Experimental investigation of the steam reformer

The University Duisburg-Essen has developed a compact multi-fuel steam reformer for residential power supply suitable for natural gas, propane and butane. A reformer unit is designed to produce 2.5 kW_{th} hydrogen power, based on the lower heating value of hydrogen of 241 kJ/mol, which may lead to an electrical power output of about 1 kW, which is typical and suitable for a one-family household. Steam reforming has been selected as gas processing technology, because the endothermic reaction heat is provided by an external burner leading to hydrogen concentrations above 75 % in the dry product gas. In contrast to steam reforming technology autothermal and partial oxidation processes generate product gas qualities containing less than 50 % hydrogen because of a high nitrogen content

while the reaction heat is supplied by internal combustion of a part of the fuel gas with air. The principal design of the process is explained referring to Figure 4, where the main reactions of each conversion step are schematically subscribed. For reformer measurements introduced in the following methane was used as fuel gas in order to have exactly defined inlet parameters for the evaluation of product gas quality and reformer efficiency. In case of real natural gas the fuel gas additionally has to be desulphurised in a bed of impregnated active carbon at room temperature from natural sulphur compound and odouring additives. After adding liquid water to the methane gas stream, evaporating the water and preheating of the mixture the reactants are converted at a Nickel catalyst at about 800 °C to form a mixture of gases of H₂, CO₂, CO, residual CH₄ and residual water steam. In the subsequent water gas shift reactors the CO content can be reduced to less than 1 % in two separate temperature steps (HT-Shift at 400 °C and LT-Shift at 200 °C) while the residual CO is removed in a special fine purification unit, the preferential oxidation or PrOx unit. After passing through a particle filter the reformat gas can now be ducted to the PEM fuel cell, where electrical power and heat are generated.

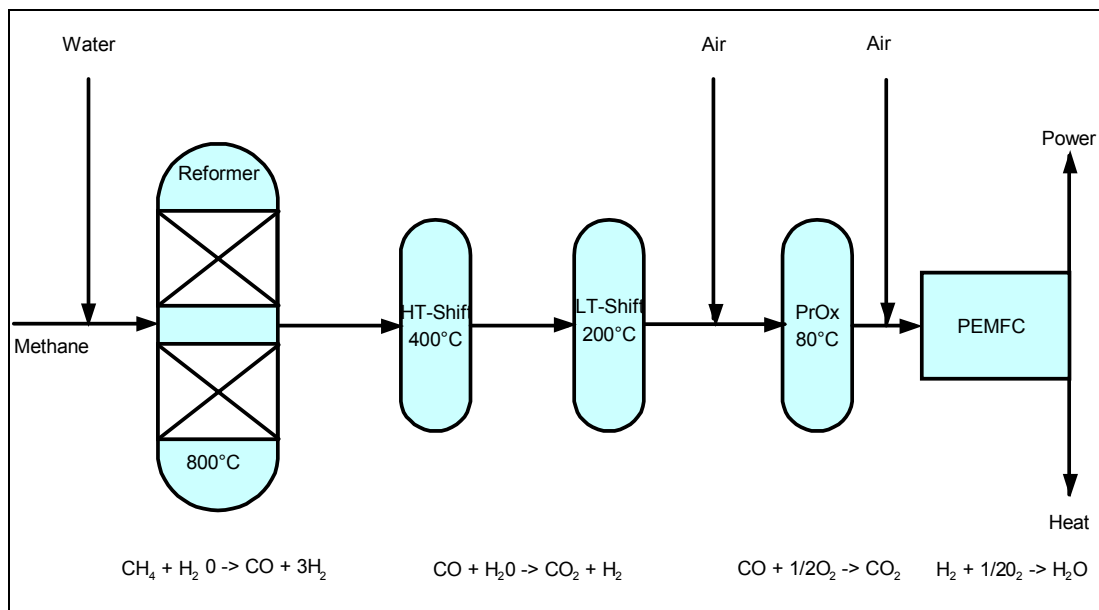

Figure 4: Principle scheme of main reactions of a steam reforming process

The developed and investigated fuel processor system is composed of low cost subunits that incorporate mainly standard components in order to get a highly modular, compact and inexpensive system. A gas processing module forms a unit, consisting of a prereformer step, a primary reformer, water gas shift reactors, a steam generator, internal heat exchangers in order to achieve an optimised heat integration and an external burner for heat supply. All these components are housed in a well insulated metal cylinder as shown in figure 5. A separate PrOx reactor is added to the fuel processor outside of the insulated cylinder in order to achieve a less elaborate temperature control of the exothermic reaction of the CO purification. For steady state operation the CO concentration of the product gas is below 50 ppm in the complete power range.

The fuel processor is designed to deliver a thermal hydrogen power output from 500 W as part load to 2,5 kW at rated power. Several of these modules may be combined to meet higher power demands. The compact design of such a module facilitates the integration in a conventional heating system. Using commercially available burner systems and inexpensive catalyst materials can lead to an economically competitive fuel processor. The estimated target costs for the fuel processor are less than 350 \$/kWel. (estimated based on mass production figures).

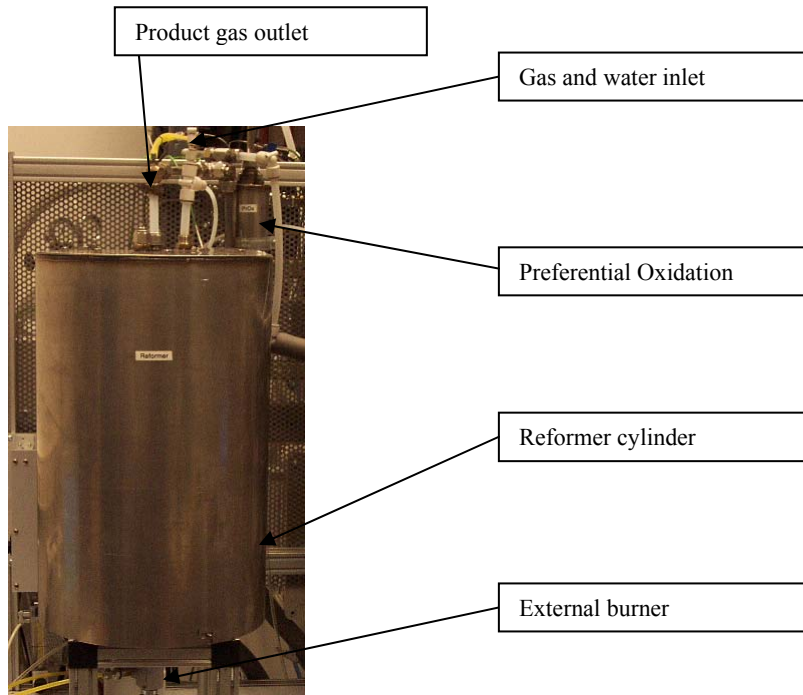

Figure 5: 2.5 kW_{th} steam reformer with separate PrOx as CO purification in the test rig

Figure 6 presents the main results of experimental tests to characterise the steady state behaviour of the reformer as a function of the load, firstly without combining the reformer with the PROX reactor. The gas composition (on dry basis) measured with an online gas analysis shows a high hydrogen content of the product gas, typical for steam reforming, which is slightly decreasing from 79.5 vol.-% at 20 % part load (corresponding to 500 W_{th}) to 78 vol.-% at rated power (corresponding to 2.500 W_{th}). According to the hydrogen decrease the CO content of the product gas and the content of residual methane is slightly increasing with respect to the load of the single reactors and the employed catalysts. The reformer efficiency $\eta_{\text{Ref,H}_2}$, defined as the lower heating value of the produced hydrogen referred to the lower heating value of the used methane for reformer educt as well as for the burner heat supply

$$\eta_{\text{Ref,H}_2} = \frac{\Delta H_{u,\text{H}_2}}{\Delta H_{u,\text{CH}_4}} \cdot \frac{\dot{n}_{\text{H}_2}^{\text{Product}}}{\dot{n}_{\text{CH}_4}^{\text{Educt}} + \dot{n}_{\text{CH}_4}^{\text{Burner}}}$$

shows a maximum figure of about 77 % at rated power. The efficiency decreases to 64 % at 20 % part load due to a less effective heat transfer of the flue gas, which results in a rising flue gas temperature and hence, increasing heat losses.

Additionally tests were performed combining the reformer with a PrOx step in order to evaluate the quality of the product gas as fuel for a fuel cell. It could be observed that the CO content was mainly lower than 50 ppm in all steady state operation measurements. The efficiency of the combined reformer/PrOx system is also presented in figure 6 showing a slight lower efficiency due to the fact, that air with an air ratio of about 3.5 (corresponding to the CO content downstream the low temperature shift reactor) is added to the gas stream in order to oxidise the carbon monoxide and hence, a small amount of hydrogen is also oxidised resulting in a somewhat lower efficiency.

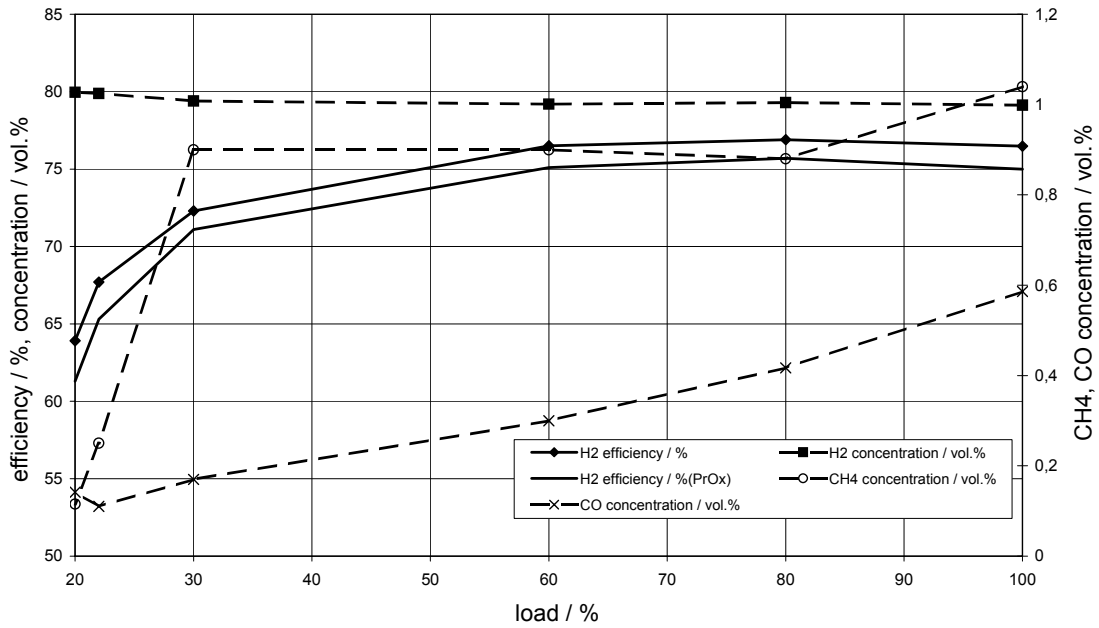

Figure 6: Gas quality and efficiencies of the reformer as a function of load for steady state operation

Coupling of reformer and fuel cell stack

The steam reformer and the fuel cell were coupled to form a process chain from methane as input and electric power as output. The feed is controlled by mass flow controllers, the gas composition can be measured downstream the LT-Shift as well as downstream the PrOx in order to prevent the stack from not tolerable product gas qualities and CO peaks. Figure 7 shows the test stand with gas supply, fuel processor with PrOx and fuel cell stack.

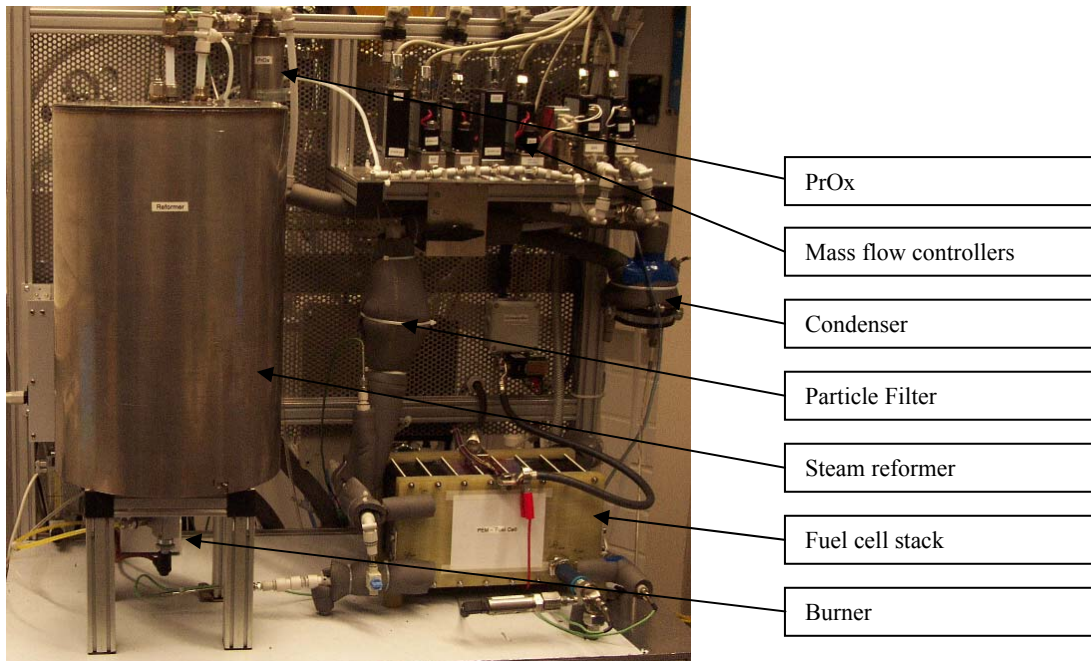

Figure 7: Coupled fuel processor/fuel cell stack process chain

Figure 8 represents the produced electrical power of the fuel cell stack dependent on the supplied hydrogen fuel gas at the stack inlet. It can be found that there is no significant deviation of the electric power produced by the fuel cell stack from of the real steam reformat gas in comparison to the synthetic reformat gas mixture. The graphs show an obvious compliance as an clear indication for the

suitable reformer product gas quality and the stable operation of the PEM stack. For both fuel gas qualities a maximum electric power of about 960 W can be achieved.

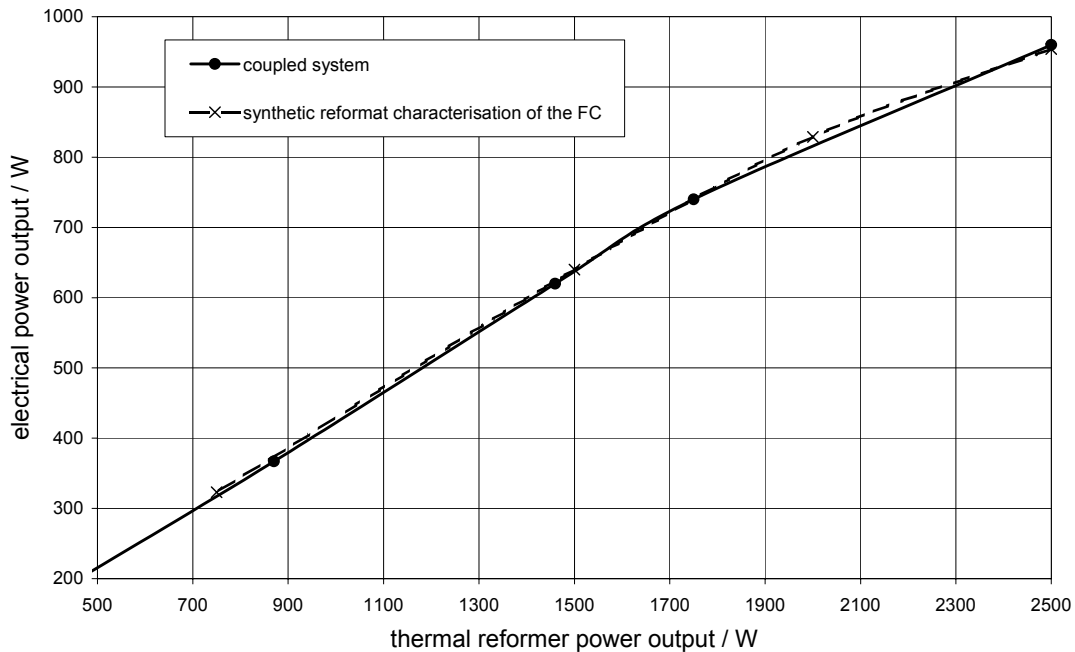

Figure 8: PEM fuel cell characterisation with synthetic reformat gas and real steam reformat gas

The following diagrams, figure 9 and figure 10, show first test results of manually operated load changes. These manual tests are necessary in order to get necessary parameters for an automatic control system. The electrical power output of the fuel cell stack and the thermal hydrogen power output of the steam reformer including PrOx step is depicted as a function of time. The load changes were performed manually in order to avoid CO peaks of the fuel processor and to establish a stable fuel cell operation. Hence, a careful and stepwise procedure was chosen in figure 9 to vary the load from 20 % part load to rated power. A load change lasts about a quarter of an hour while keeping the CO content downstream the PrOx under 50 ppm most of the time in order to prevent the fuel cell stack from not tolerable CO peaks. The CO concentration rises up to 80 ppm only for a short period of time. Figure 10 presents an analogous load change reducing the electrical power to 20 %. The procedure can be performed in about 5 min while a short CO peak with 90 ppm can be observed. Hence, at the time being the performance of the PrOx reactor is restricting the dynamic behaviour of the complete process chain. An optimised PrOx step, an automatic control and a higher tolerable short term CO level for the will reduce the necessary load change time significantly.

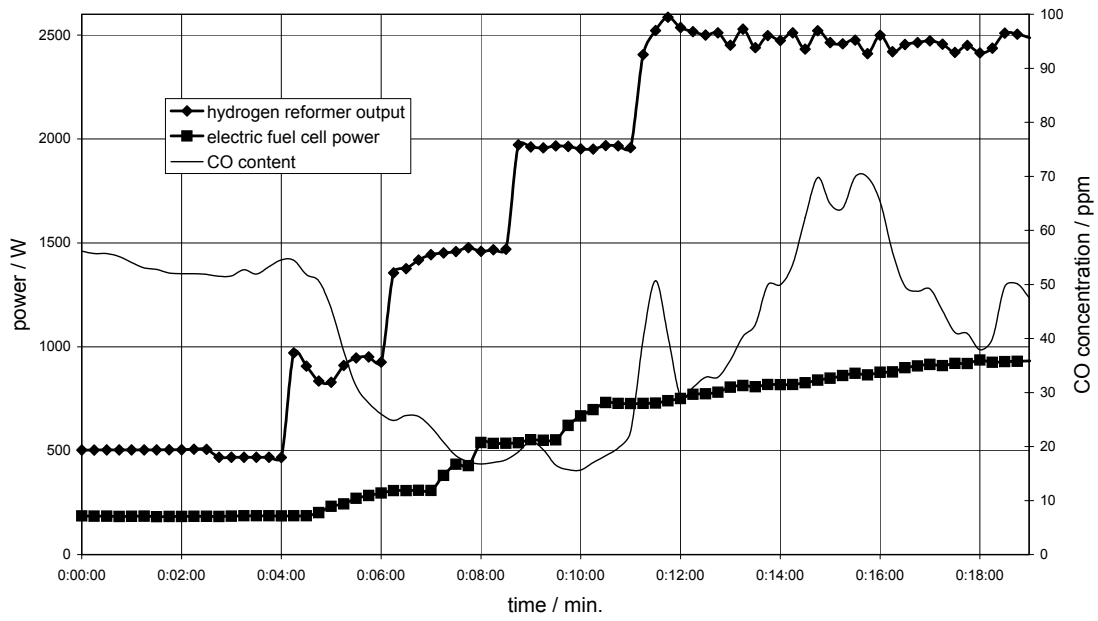

Figure 9: Manually operated load change from 20 % part load to rated power output

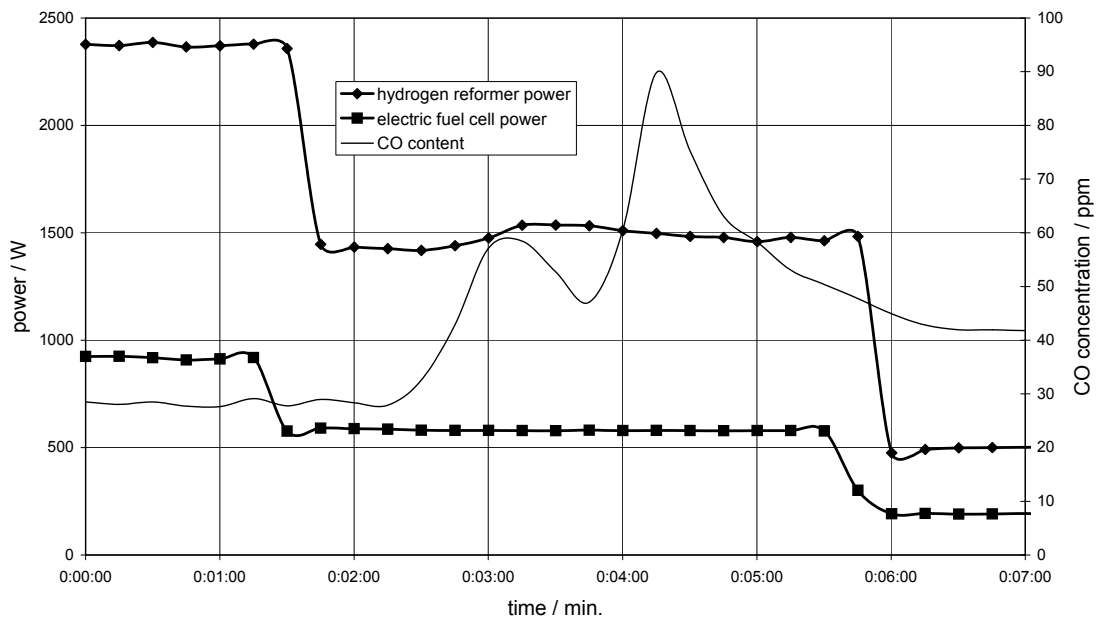

Figure 10: Manually operated load change from 95 % part load to 20 % part load

Summary and conclusion

A steam reformer for residential power supply, developed at the University of Duisburg-Essen, was combined with a PEM fuel cell. The fuel processor, suitable for natural gas, propane, butane and LPG is designed to deliver a thermal hydrogen output from 500 W to 2,5 kW. The fuel processor and the fuel cell stack were evaluated separately as well as combined to a process chain.

A fuel cell stack suitable for reformat gas and operating at nearly ambient pressure was selected. The fuel cell meets typical requirements for residential power supply applications like low pressure drop, low air to fuel ratio and internal humidification of the cathode air. No significant influence of the air bleed on the short term performance of the fuel cell could be detected and no clear influence of added carbon monoxide could be observed. The air bleed removes CO traces up to 50 ppm without a performance loss.

The separate reformer tests show a wide stable operation range from 20 % part load to rated power, a high efficiency of about 77 % at full load and a high product gas quality with less than 50 ppm CO in all steady state operation points.

The steam reformer was coupled successfully with the PEM fuel cell stack and the high reformer product gas quality could be approved by achieving the same stack performance as in the case of a synthetic reformat gas mixture. Actually the performance of the PrOx reactor limits the dynamic behaviour of the complete system.

Currently a variety of improvements is under development. An optimised PrOx reactor is tested at the time being in order to advance dynamic load changes. A recirculation of the anodic off gas containing residual hydrogen and not converted methane to the reformer burner will increase the overall efficiency significantly. Furthermore replacing the mass flow controllers by valves, pumps and blowers and implementing an automatic control will lead to a complete fuel cell system for residential power supply.

Acknowledgements

Financial support by the Landesinitiative Zukunftsenergien Nordrhein-Westfalen (Development of a 1 kW Fuel Cell System for Residential Power Supply, project number 85.65.69-T-117) is gratefully acknowledged.

References

- [1] J. Mathiak
Verfahrensanalyse zur dezentralen Hausenergieversorgung auf Basis von PEM-Brennstoffzellen
Dissertation Universität Duisburg-Essen, Logos Verlag Berlin, Berlin 2003
- [2] A. Heinzl, M. Dokupil, F. Mahlendorf, J. Mathiak, J. Roes
Multi Fuel Steam Reforming for PEM Fuel cell Systems
2002 Fuel Cell Seminar, Abstracts, Palm Springs, California, USA, 2002, 721 – 724
- [3] A. Lehmann, F. Mahlendorf, J. Mathiak, J. Roes
Electricity and Heat via Natural Gas Reforming/PEMFC for Residential Power Supply
2000 Fuel Cell Seminar, Portland, Oregon, USA, 2000, 313 – 316